



1

Preface

*Notebook
User's Manual*



Contents

Chapter 1: Preface

| | |
|---|------------|
| Content | 1-2 |
| Regulations and Statements | 1-4 |
| FCC-B Radio Frequency Interference Statement..... | 1-4 |
| FCC Conditions | 1-4 |
| CE Conformity | 1-4 |
| Battery Regulations | 1-5 |
| WEEE Statement..... | 1-5 |
| Safety Instructions | 1-6 |
| Optical Device Drive Notice | 1-8 |
| Trademarks | 1-8 |
| Reversion History | 1-8 |

Chapter 2: Introductions

| | |
|-------------------------------|-------------|
| Manual Map | 2-2 |
| Unpacking | 2-2 |
| Product Overview | 2-3 |
| Top-Open View | 2-3 |
| Front Side View | 2-7 |
| Right Side View | 2-9 |
| Left Side View | 2-10 |
| Rear Side View | 2-12 |
| Bottom Side View | 2-13 |
| Specification | 2-14 |

Chapter 3: Getting Started

| | |
|--|------------|
| Begin to Use the Notebook | 3-2 |
| Power Management | 3-3 |
| AC Power..... | 3-3 |
| Battery Power | 3-3 |
| Power Management in Windows OS | 3-7 |

| | |
|---|-------------|
| Energy Saving Tips | 3-8 |
| Basic Operations | 3-9 |
| Safety and Comfort Tips | 3-9 |
| Knowing the Keyboard..... | 3-11 |
| Knowing the Touchpad..... | 3-15 |
| About Hard Disk Drive | 3-17 |
| Using the Optical Storage Device | 3-37 |
| Connecting the External Devices | 3-19 |
| Peripheral Devices..... | 3-19 |
| Communication Devices | 3-20 |
| Components Replacement and Upgrade | 3-21 |
| FAQ | 3-23 |

❖ Regulations and Statements

FCC-B Radio Frequency Interference Statement

This equipment has been tested and found to comply with the limits for a Class B digital device, pursuant to part 15 of the FCC rules. These limits are designed to provide reasonable protection against harmful interference in a residential installation. This equipment generates, uses and radiates radio frequency energy, and, if not installed and used in accordance with the instructions, may cause harmful interference to radio communications. However, there is no guarantee that interference will not occur in a particular installation. If this equipment does cause harmful interference to radio or television reception, which can be determined by turning the equipment off and on, the user is encouraged to try to correct the interference by one or more of the following measures:

- Reorient or relocate the receiving antenna.
- Increase the separation between the equipment and receiver.
- Connect the equipment into an outlet on a circuit different from that to which the receiver is connected.
- Consult the dealer or an experienced radio TV technician for help.

NOTE

- ♦ The changes or modifications not expressly approved by the party responsible for compliance could void the user's authority to operate the equipment.
- ♦ Shield interface cables and AC power cord, if any, must be used in order to comply with the emission limits.

FCC Conditions

This device complies with part 15 of the FCC Rules. Operation is subject to the following two conditions:

- This device may not cause harmful interference.
- This device must accept any interference received, including interference that may cause undesired operation.

CE Conformity



This device is in compliance with the essential safety requirements and other relevant provisions set out in the European Directive.

Battery Regulations



European Union:

Batteries, battery packs, and accumulators should not be disposed of as unsorted household waste. Please use the public collection system to return, recycle, or treat them in compliance with the local regulations.



廢電池請回收

Taiwan:

For better environmental protection, waste batteries should be collected separately for recycling or special disposal.

California, USA: The button cell battery may contain perchlorate material and requires special handling when recycled or disposed of in California.

For further information please visit: <http://www.dtsc.ca.gov/hazardouswaste/perchlorate/>

Safety Guideline for Using Lithium Battery

Danger of explosion if battery is incorrectly replaced. Replace only with the same or equivalent type recommended by the equipment manufacturer. Discard used batteries according to manufacturer's instructions.

WEEE Statement

Under the European Union ("EU") Directive on Waste Electrical and Electronic Equipment, Directive 2002/96/EC, which takes effect on August 13, 2005, products of "electrical and electronic equipment" cannot be discarded as municipal waste anymore and manufacturers of covered electronic equipment will be obligated to take back such products at the end of their useful life.



❖ Safety Instructions



Read the safety instructions carefully and thoroughly. All cautions and warnings on the equipment or user's manual should be noted.



Keep this equipment away from humidity and high temperature.



Lay this equipment on a stable surface before setting it up.



The openings on the enclosure are used for air convection and to prevent the equipment from overheating. Do not cover the openings.



- Do not leave the equipment in an unconditioned environment with a storage temperature above 60°C (140°F) or below 0°C (32°F), which may damage the equipment.
- This unit should be operated under maximum ambient temperature of 40°C (120°F).



- Make sure the power voltage is within safety range and has been adjusted properly to the value of 100~240V before connecting the equipment to the power outlet.
- Always unplug the AC power cord before installing any add-on card or module to the equipment.
- Always disconnect the AC power cord or uninstall the battery pack or switch off the wall socket if the equipment would be left unused for a certain time to achieve zero energy consumption.



Never pour liquid into the opening that could damage the equipment or cause an electrical shock.



Place the power cord in a way that people are unlikely to step on it. Do not place anything on top of the power cord.



Always keep the strong magnetic or electrical objects away from the equipment.



When installing the coaxial cable to the TV Tuner, it is necessary to ensure that the metal shield is reliably connected to protective earthing system of the building.

Cable distribution system should be grounded (earthed) in accordance with ANSI/NFPA 70, the National Electrical Code (NEC), in particular Section 820.93, Grounding of Outer Conductive Shield of a Coaxial Cable.



- To prevent explosion caused by improper battery replacement, use the same or equivalent type of battery recommended by the manufacturer only.
- Always keep the battery in a safe place.



If any of the following situations arises, get the equipment checked by a service personnel:

- The power cord or plug is damaged.
- Liquid has penetrated into the equipment.
- The equipment has been exposed to moisture.
- The equipment has not worked well or you can not get it work according to User's Manual.
- The equipment was dropped and damaged.
- The equipment has obvious signs of breakage.

Green Product Features

- Reduced energy consumption during use and stand-by
- Limited use of substances harmful to the environment and health
- Easily dismantled and recycled
- Reduced use of natural resources by encouraging recycling
- Extended product lifetime through easy upgrades
- Reduced solid waste production through take-back policy



Environmental Policy

- The product has been designed to enable proper reuse of parts and recycling and should not be thrown away
- Users should contact the local authorized point of collection for recycling and disposing of their end-of-life products.

❖ Optical Device Drive Notice

CAUTION: This appliance contains a laser system and is classified as a “CLASS 1 LASER PRODUCT.” To use this model properly, read the instruction manual carefully and keep this manual for your future reference. In case of any trouble with this model, please contact your nearest “AUTHORIZED service station.” To prevent direct exposure to the laser beam, do not try to disassemble the enclosure.

❖ Trademarks

- All trademarks are the properties of their respective owners.
- SRS Premium Sound, SRS and the symbol are trademarks of SRS Labs, Inc.
- THX and THX TruStudio Pro are trademarks of THX Ltd. which may be registered in some jurisdictions. All rights reserved.

❖ Revision History

| Version | Revision History | Date |
|---------|------------------|----------|
| 1.0 | First Released | 02, 2012 |



2



Introductions

Congratulations on becoming an user of this notebook, the finely designed notebook. This brand-new exquisite notebook will give you a delightful and professional experience in using notebook. We are proud to tell our users that this notebook is thoroughly tested and certified by our reputation for unsurpassed dependability and customer satisfaction.

❖ Manual Map

This User's Manual provides instructions and illustrations on how to operate this notebook. It is recommended to read this manual carefully before using this notebook.

Chapter 1, Preface, gives users the basic safety information and caution that is interrelated to using this notebook. It is recommended to read these information or caution when using this notebook for the first time.

Chapter 2, Introductions, includes the descriptions of all the accessories of this notebook. It is recommended to check out that if you have all the accessories included when you open the packing box. If any of these accessories is damaged or missing, please contact the vendor where you purchased this notebook. Also, this chapter provides the specification of this notebook, and introduces the function buttons, quick launch buttons, connectors, LEDs and externals of this notebook.

Chapter 3, Getting Started, gives the basic operation instructions on using keyboard, touchpad, hard disk drive, and optical storage drive. Beside, the steps of installing and uninstalling the battery; and the procedures of connecting the various external devices, communication devices, and so on, are also provided to help users getting familiar with this notebook.

❖ Unpacking

First, unpack the shipping carton and check all items carefully. If any item contained is damaged or missing, please contact your local dealer immediately. Also, keep the box and packing materials in case you need to ship the unit in the future. The package should contain the following items:

- Notebook
- Quick Start Manual
- High-capacity Li-ion battery
- AC/DC adapter and AC power cord
- Carry bag (optional)
- All-in-one application disk, containing the full version of user's manual, drivers, utilities, and optional recovery function, etc..

❖ Product Overview

This section provides the description of basic aspects of the notebook. It will help you to know more about the appearance of this notebook before using it. Please be aware that the notebook shown in this section may vary from the actual one that users purchased.

Top-open View

The figure of top-open view and description shown below will lead you to browse the main operating area of your notebook.

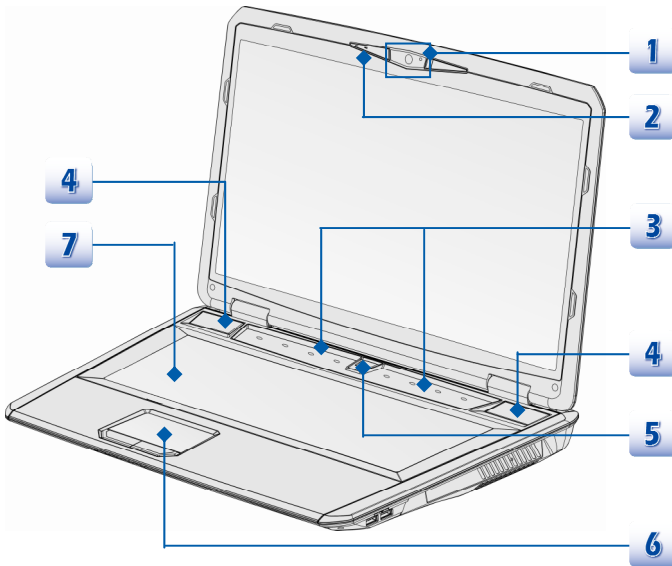

These accessories listed above may change without notice.

1. **Webcam**

- This built-in Webcam can be used for picture taking, video recoding or conferencing, and any other interactive applications.
- Webcam LED indicator, next to the webcam, grows orange when webcam function is activated; LED goes out when this function is turned off.

2. **Internal Microphone**

This is the built-in microphone and its function is the same with microphone.

3. **Quick Launch Buttons**

Press the quick launch buttons to activate the specific applications or tools. The following Quick Launch Buttons will only be functional in the Operating System with the S-Bar application installed. Find the S-Bar application in the all-in-one disk that comes with the package for easy and convenient operation. It is strongly recommended to install the S-Bar application.



ODD Eject

- Touch this sensor to eject the disc tray of the optical device drive.
- **Please Note:** The ODD Eject sensor is functional under pure DOS system. However, in an Operating System without the S-Bar application installed, the Eject sensor will not be functional.
In such a case, users can right-click the ODD in "My Computer" and select "Eject" to eject the ODD tray.



Display Off

- Touch this sensor to switch the display off instantly to economize the power consumption.
- Hit any key at the keyboard to switch on the display.



Bluetooth

- Touch this sensor repeatedly to turn the Bluetooth function on or off recurrently.



WLAN (WiFi)

- Touch this sensor repeatedly to turn the WLAN function on or off recurrently.



- Touch this sensor to turn the Webcam function on or off.



Cooler Boost

- ◆ Touch this sensor to increase the fan speed to cool down the overall temperature of the notebook.
- ◆ Touch this sensor repeatedly to turn this function on or off recurrently.



Media Player

- ◆ Touch this sensor to activate the Media Player function which enhances the playback quality from your display device and sound system. Touch this sensor again to turn this function off.

P1

User Defined

- ◆ Touch this sensor to launch the User Defined application. system. Touch this sensor again to turn this function off.
-

4. Stereo Speakers

Give high quality sound blaster with stereo system and Hi-Fi function supported.

5. Power Button / Power LED

Power Button



- ◆ Press the power button to turn the notebook power ON and OFF.
- ◆ Press the power button to awake the notebook from the sleep state.

Power/ Power Saving function LED

- ◆ Glowing white when the notebook power is turned on.
 - ◆ LED goes off when this function is turned off.
-

6. Touchpad

This is the pointing device of the notebook.

7. Keyboard

The built-in keyboard provides all the functions of a full-sized keyboard.

Quick Launch [Fn] Buttons

Use the [Fn] buttons on the keyboard to activate the specific applications or tools.

With the help of these quick launch buttons, users will be able to do work more efficiently.

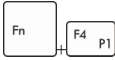

**User Defined
or
Windows Search
(optional)**

- ◆ Press and hold the Fn button, and then press the **F4** button to launch the **User Defined** application.
- ◆ Or, press and hold the Fn button, and then press the **F4** button to launch the **Windows Search** function.



**ECO Engine
(Power Saving)**

- ◆ Press and hold the Fn button, and then press the **F5** button repeatedly to switch among various power saving modes provided by **ECO Engine**, or to turn this function off recurrently.



Webcam

- ◆ Press and hold the Fn button, and then press the **F6** button to turn the **Webcam** function on. Press again to turn it off.



**WLAN
(WiFi)**

- ◆ Press and hold the Fn button, and then press the **F8** button repeatedly to turn the **Wireless LAN (WiFi)** function on or off recurrently.



**Bluetooth
(Optional)**

- ◆ Press and hold the Fn button, and then press the **F9** button to turn the **Bluetooth** function on. Press again to turn it off.
- ◆ This function button will not be available when the Bluetooth function is not supported.

Front Side View

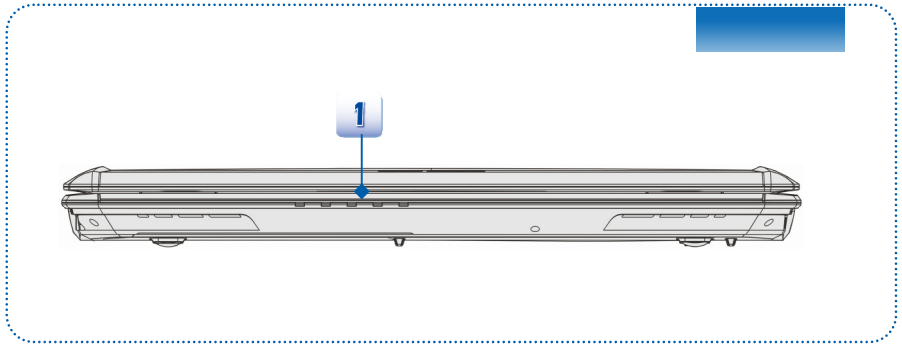

1. Status LED



Hard Disk/ Optical Drive Device In-use

Blinking amber when the system is accessing the hard disk drive or the optical drive device.



Sleep State

- Blinking amber when the system is in Sleep state.
- LED goes out when the system is turned off.



Battery Status

- Glowing amber when the battery is being charged.
- Blinking amber if the battery fails and it is recommended to replace a new battery.
- Consult the local dealer for purchasing an equivalent type of battery recommended by the manufacturer.
- Battery LED goes out when it is fully charged or when the AC/DC adapter is disconnected.



Bluetooth

Bluetooth

- Bluetooth LED indicator glows amber when Bluetooth function is enabled.
- Warning: For flight safety consideration, make sure this LED indicator goes out when you are in flight.
- Note: The Bluetooth Function may be optional supported depending on the model users purchased.

-
- Contact the local distributor for further information if necessary.
-

Wireless LAN (WiFi)



WLAN(WiFi)

- This LED indicator glows amber when **Wireless LAN (WiFi)** function is enabled.
 - LED indicator goes out when this function is disabled.
 - **Note:** Functions listed here may be optional supported depending on the model users purchased.
 - **Warning:** For flight safety consideration, make sure this LED indicator goes out when you are in flight.
 - Contact the local distributor for further information if necessary.
-

Right Side View

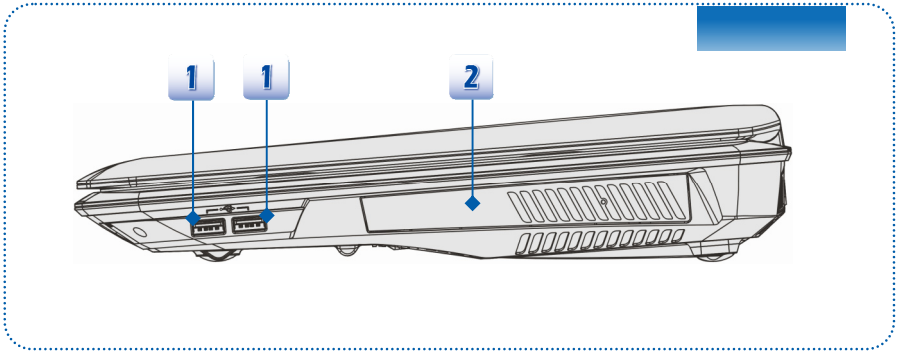

1. USB 2.0 Ports

The USB 2.0 port allows you to connect USB-interface peripheral devices, such as the mouse, keyboard, modem, portable hard disk module, printer and more.

2. Optical Drive Device

This notebook is equipped with an optical drive device. The actual device preinstalled in the notebook depends on the model you purchased.

Left Side View

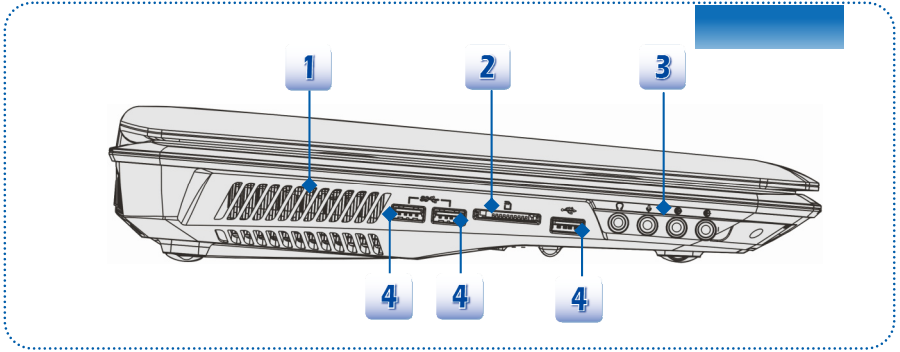

1. Ventilator

The ventilator is designed to cool the system. DO NOT block the ventilator for air circulation.

2. Card Reader

The built-in card reader may support various types of memory card, such as MMC (Multi-Media Card), XD (eXtreme Digital), SD (Secure Digital), SDHC (SD High Capacity), SDXC(SD eXtended Capacity), MS (Memory Stick) or MS Pro (Memory Stick Pro) cards, depending on the model users purchase. Contact the local dealer for further and correct information and be noted that the supported memory cards may vary without notice.

3. Audio Port Connectors

Make high quality sound blaster with stereo system and Hi-Fi function supported.

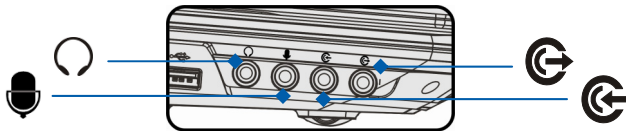

Headphone out/ SPDIF-out



- Used for speakers or headphones. The S/PDIF connector is also provided for digital audio transmission to external speakers through an optical fiber cable.
- Connect the Front speakers here.



Microphone

- Used for an external microphone.
- Connect the Center and Subwoofer speakers here.

**Line In**

- ◆ Used for an external audio device.
- ◆ Connect the Rear speakers here.

**Line Out**

- ◆ A connector for speakers.
 - ◆ Connect the Surround speakers here.
-

4. USB 3.0 Ports

USB 3.0, the SuperSpeed USB, delivers the higher interface speeds for connecting various devices, such as storage devices, hard drives, or video cameras, and offers more advantages over high-speed data transferring.

Rear Side View

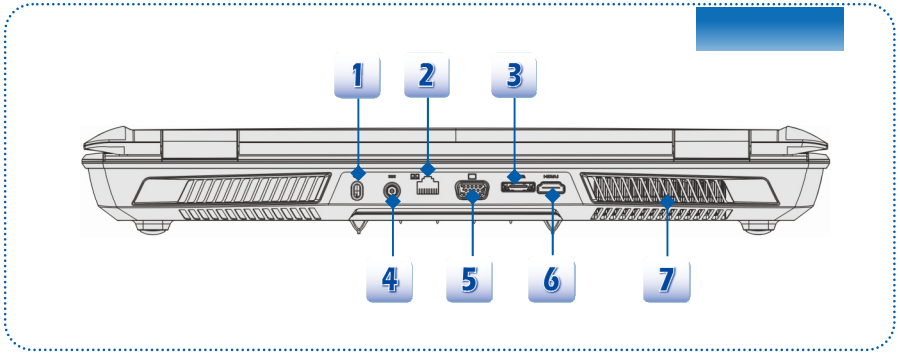

1. Kensington Lock

This notebook provides a Kensington Lock hole, which allows users to secure the notebook in place with a key or some mechanical PIN device and attached through a rubberised metal cable. The end of the cable has a small loop which allows the whole cable to be looped around a permanent object, such as a heavy table or other similar equipment, thus securing the notebook in place.

2. RJ-45 Connector

The 10/100/1000 Ethernet connector is used to connect a LAN cable for network connection.

3. E-SATA (External Serial ATA)

The E-SATA Connector allows you to connect an external Serial ATA hard disk device. Users can now utilize shielded cable outside the notebook to take advantage of the benefits the SATA interface brings to storage.

4. Power Connector

To connect the AC/DC adapter and supply power for the notebook.

5. VGA Port

The 15-pin-D-sub VGA port allows you to connect an external monitor or other standard VGA-compatible device (such as a projector) for a great view of the computer display.

6. HDMI Connector **HDMI™**

HDMI (High Definition Multimedia Interface) is a new interface standard for PCs, displays and consumer electronics devices that supports standard, enhanced and high-definition video, plus multi-channel digital audio on a single cable.

7. Ventilator

The ventilator is designed to cool the system. DO NOT block the ventilator for air circulation.

Bottom Side View

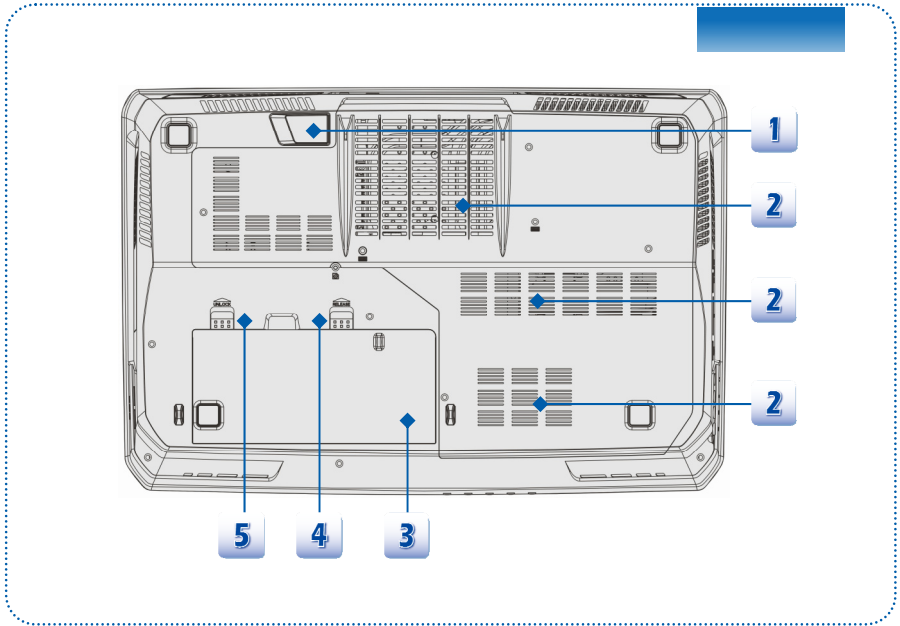

1. Stereo Speakers

Give high quality sound blaster with stereo system and Hi-Fi function supported.

2. Ventilator

The ventilator is designed to cool the system. DO NOT block the ventilator for air circulation.

3. Battery Pack

This notebook will be powered by the battery pack when the AC/DC adapter is disconnected.

4. Battery Release Button

It is a bounce-back device as a preparation for releasing the battery pack. Slide it with one hand and pull the battery pack carefully with the other.

5. Battery Lock/Unlock Button

Battery cannot be moved when the button is positioned on lock status. Once the button is slid to unlock position, the battery is removable.

❖ Specification

The Specification may change without notice. The actual products sold are different from areas. Please check the detailed Specification with your local dealers.

| Physical Characteristic | |
|--|---|
| Dimension | 428(W) x 288 (D) x 55 (H) mm |
| Weight | <4.2 kg (with 9-cell battery) |
| CPU | |
| Socket | 989 pins, rPGA |
| Processor Type | Intel® Chief River Ivy Bridge |
| Supported Processor | Intel® Quad/ Dual-Core processor |
| L3 Cache | UP to 8MB (Based on CPU) |
| Core Chips | |
| North Bridge | Intel® Chief River Ivy Bridge |
| South Bridge | Intel® Panther Point HM77 |
| Memory | |
| Technology | DDR3 1600/ 1333 MHz |
| Memory | DDR3 SO-DIMM X 4 slots 1G/2G/4G/8G MB DDR III SDRAM |
| Maximum | up to 32 GB |
| Power | |
| AC/DC Adapter | 180W, 19V Input: 100~240V, ~2.25 50~60Hz Output: 19V --- 9.5A  |
| Battery Type | 9-cell |
| RTC Battery | Yes |
| Storage (items listed here may vary without notice) | |
| HDD form factor | 2.5" HDD |
| Optical Drive Device | Super Multi / Blu-ray (optional) |

I/O Port

| | |
|---------------|---|
| Monitor (VGA) | D-Sub x 1 |
| USB | x 3 (version 3.0) x 2 (version 2.0) |
| Mic-in | x 1 |
| Line-in | x 1 |
| Headphone-out | x 1 (SPDIF-Out supported) |
| E-SATA | x 1 |
| Side-Out | x 1 |
| RJ45 | x 1 |
| HDMI | x 1 |
| Card Reader | x 1 (SDXC/ XD/ MMC/ MS) (support SD 3.0, SDXC) The supported memory cards may vary without notice. |

Communication Port

| | |
|--------------|--------------------------|
| LAN | 10/ 100/ 1000Mb Ethernet |
| Wireless LAN | Optionally supported |
| Bluetooth | Optionally supported |

Display

| | |
|------------|----------------------------|
| LCD Type | 17.3" LED panel |
| Brightness | Controlled by K/B hot-keys |

Video

| | |
|--------------------|---|
| Graphics | NVIDIA GeForce discrete graphics |
| VRAM | GDDR5, 1.5GB |
| CRT output | Supported |
| HDMI output | Supported |
| Dual View Function | Supported External display devices will be auto detected when connected. |

| Audio | |
|----------------------------|----------------------------------|
| Internal Speaker | 2 speakers + 1 sub-woofer |
| Sound Volume | Adjust by K/B hot-key & SW |
| Software & BIOS | |
| USB Flash Boot | Yes, USB floppy boot up DOS only |
| BIOS | Fast Boot Support --- Yes |
| Others | |
| Compliance | WHQL |
| Kensington Lock Hole | x 1 |



3



Getting Started

❖ Begin to Use the Notebook

For a new user of this notebook, we would like to suggest you follow the illustrations below to begin to use the notebook.

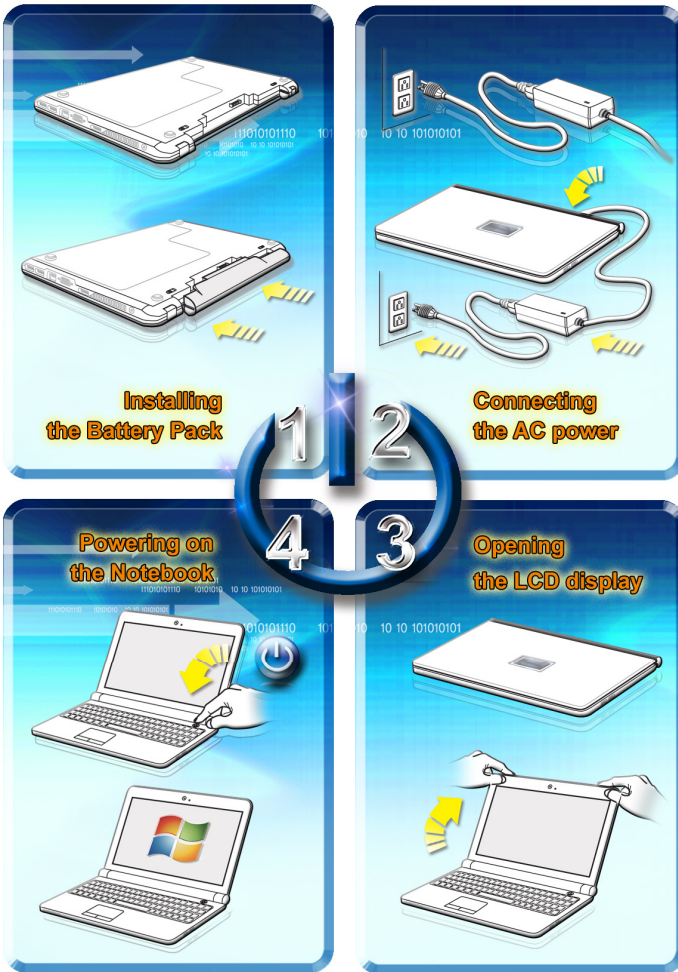

❖ Power Management

AC Power

It is strongly recommended to connect the AC/DC adapter to the notebook and use the AC power while using this notebook for the first time. When the AC power is connected, recharging the battery will start immediately.

Note that the AC/DC adapter included in the package is approved for your notebook; using other adapter model may damage either the notebook or other devices attached to it.

Do not cover the AC/DC adapter since it may produce a certain heat while in use. Always be aware of heat coming from the AC/DC adapter in use.

Battery Power

This notebook is equipped with a high-capacity Li-ion battery pack. The rechargeable Li-ion battery pack is an internal power source of the notebook.

Be aware of that this battery pack may be damaged if users try to disassemble the battery pack on their own. Also, note that the limited warranty to the battery pack may also lose its efficacy when this battery pack is disassembled not by an authorized machinist.

To prevent explosion caused by improper battery replacement, use the same or equivalent type of battery recommended by the manufacturer only.

Always keep the battery which is not in use in a safe place.

Please follow your local laws and regulations to recycle the unused battery pack.

It is always recommended to have another battery pack in reserve for enough power supply. Please contact your local dealer to purchase a battery pack that is compliant to your notebook.

Installing the Battery Pack

1. Align and place the battery to the battery tray with correct orientation.
2. Press down the battery pack to fasten the battery pack in the battery tray.
3. Press the lock/unlock button to the Lock position to make sure the battery pack is securely fastened.

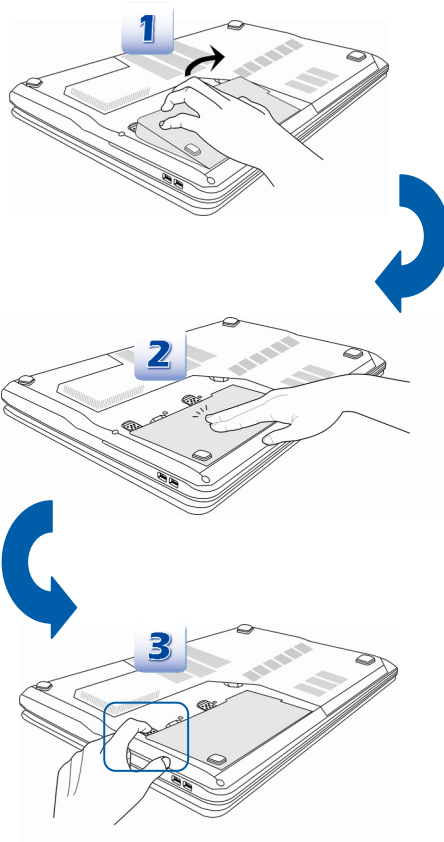

Releasing the Battery Pack

1. Before releasing the battery, make sure the notebook is turned off, and the AC power is disconnected.
2. Press the lock/unlock button to the unlocked position.
3. Locate the battery release button on the bottom side.
4. Push and hold the release button to the battery releasing direction as shown on the bottom side.
5. Dig the edge of battery pack out of the battery tray with your finger tip.
Be careful with your finger while trying to take out the battery pack.
6. And then pull the battery pack out.

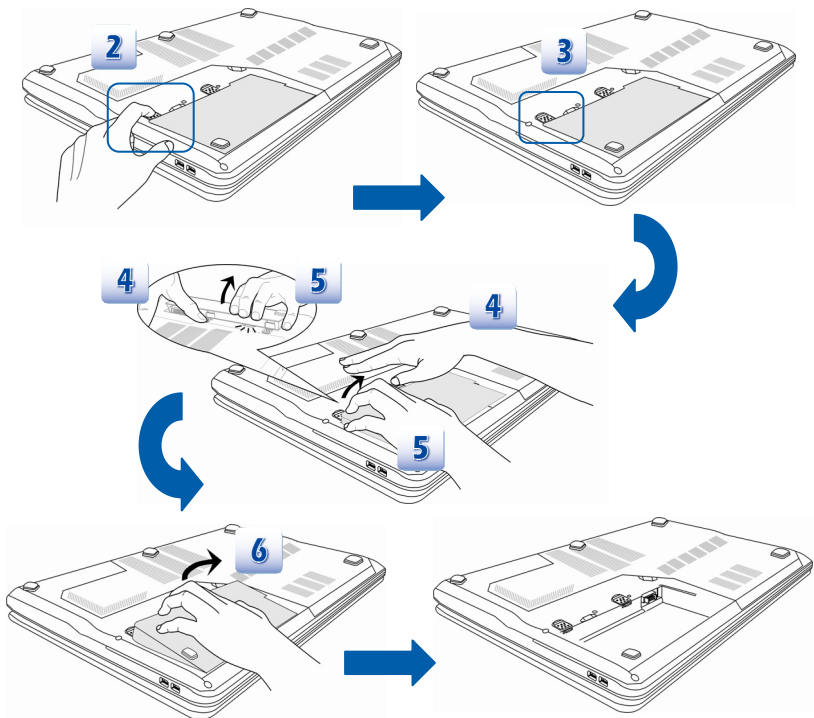

Battery Safety Tips

Replacing or handling the battery incorrectly may present a risk of fire or explosion, which could cause serious injury.

- ◆ Only replace the main battery pack with the same or equivalent type of battery.
- ◆ Do not disassemble, short-circuit or incinerate batteries or store them to temperatures above +60° C (+140° F).
- ◆ Do not temper with batteries. Keep away from the reach of children.
- ◆ Do not use rusty or damaged batteries.
- ◆ Dispose of batteries according to local regulations. Check with your local solid waste officials for details about recycling options or for proper disposal in your area.

Conserving Battery Power

Efficient battery power is critical to maintain a normal operation. If the battery power is not managed well, the saved data and customized settings may be lost.

To optimize battery life and avoid a sudden power loss, read the tips below:

- ◆ Suspend system operation if the system will be idle for a while or shorten the suspend timer's time period.
- ◆ Turn off the system if you won't be using it for a period of time.
- ◆ Disable unnecessary settings or remove idle peripherals.
- ◆ Connect an AC/DC adapter to the system whenever possible.

Charging the Battery Pack

The battery pack can be recharged while it is installed in the notebook. Please pay attention to the following tips before recharging the battery:

- ◆ If a charged battery pack is not available, save your work and close all running programs and shut down the system or Save-to-Disk.
- ◆ Plug in an external AC/DC adapter.
- ◆ You can use the system, suspend system operation or shut down and turn off the system without interrupting the charging process.
- ◆ The battery pack uses Lithium-ion battery cells that have no "memory effect." It is unnecessary to discharge the battery before recharging. However, to optimize the life of battery, we suggest that consuming the battery power completely once a month is necessary.
- ◆ If you do not use the notebook for a long time, it is suggested to remove the battery pack from your notebook. This may be helpful to extend your battery life.
- ◆ The actual charging time will be determined by the applications in use.

Power Management in Windows OS

Power management of personal computers (PCs) and monitors has the potential to save significant amounts of electricity as well as deliver environmental benefits. To be energy efficient, turn off your display or set your PC to standby/hibernate mode after a period of user inactivity.

Follow the instructions below to adjust the power management settings in Windows OS:

Power Options in Windows OS allow you to control the power management features of your display, hard drive, and battery.

1

Go to the Start menu and click on the Control Panel.
Click on the System and Security.

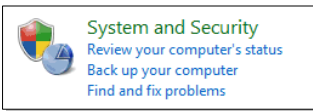

2

Then click on the Power Options.

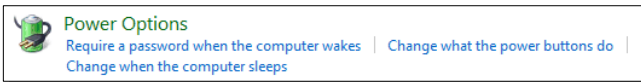

3

Then select a power plan that meets your personal needs

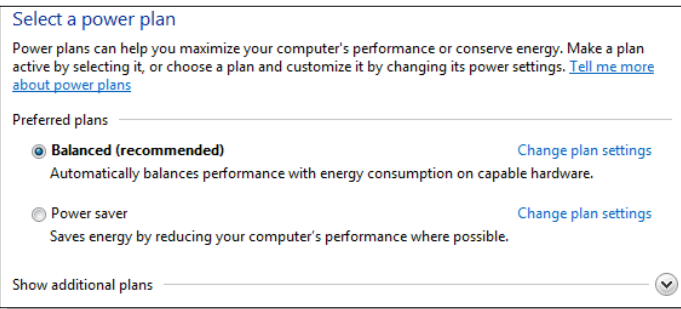

4

The Shut Down Computer menu will present the options to Sleep (S3/S4), Shut Down (S5), or Restart your computer.

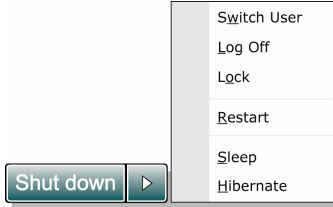

5

The computer should be able to wake up from power saving mode in response to a command from the power button.

Energy Saving Tips

1. Activate the ECO power saving function to manage the computer's energy consumption.
2. Turn off the monitor after a period of user inactivity.
3. Utilize the Fn and F12 sleep mode keys to turn into power saving mode.
4. Tune the settings in Power Options under Windows OS to optimize the computer's power management.
5. Always disconnect the AC power cord or uninstall the battery pack or switch off the wall socket if the computer would be left unused for a certain time to achieve zero energy consumption.

❖ Basic Operations

If you are a beginner to the notebook, please read the following instructions to assure your own safety, and make yourself comfortable during the operations.

Safety and Comfort Tips

The notebook is a portable platform that allows you to work anywhere. However, choosing a good workspace is important if you have to work with your notebook for a long period of time.

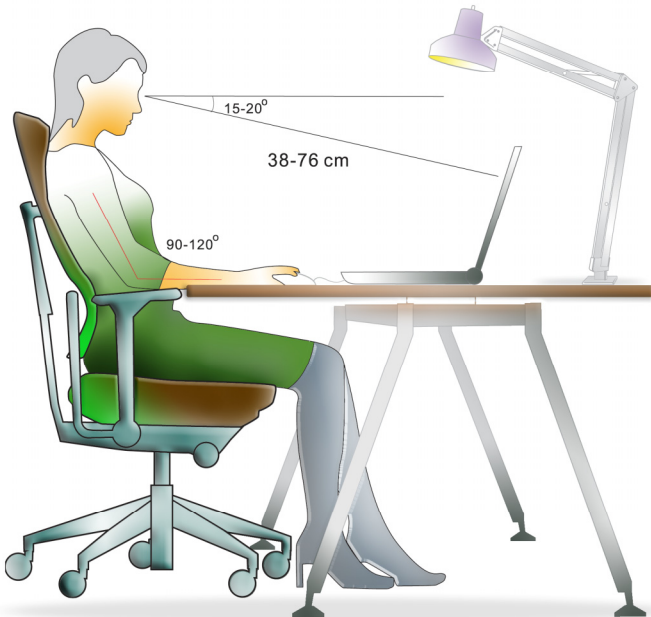

1. Your work area should have enough illumination.
2. Choose the proper desk and chair and adjust their height to fit your posture when operating.
3. When sitting on the chair, adjust the chair's back (if available) to support your back comfortably.
4. Place your feet flat and naturally on the floor, so that your knees and elbows have the proper position (about 90-degree) when operating.
5. Put your hands on the desk naturally to support your wrists.
6. Adjust the angle/position of the LCD panel to have an optimal view.
7. Avoid using your notebook in the space where it may cause you discomfort (such as on the bed).
8. Change your posture frequently.
9. Stretch and exercise your body regularly.
10. Remember to take a break after working for a period of time.

Knowing the Keyboard

This notebook provides a full-functioned keyboard. This keyboard can be divided into four categories: Typewriter keys, Cursor keys, Numeric keys and Function keys.

1



2



3



1. Typewriter keys
2. Numeric keys
3. Cursor keys / Function keys

Typewriter Keys

In addition to providing the major function of the keyboard, these typewriter keys also provide several keys for special purposes, such as [Ctrl,] [Alt,] and [Esc] key.

When the lock keys are pressed, the corresponding LEDs will light up to indicate their status:

1. Num Lock: Press this key to toggle the Num Lock on and off. When this function is activated, you can use the numeric keys that are embedded in the typewriter keys.
2. Caps Lock: Press this key to toggle the Caps Lock on and off. When this function is activated, the letters you type are kept in uppercase.
3. Scroll Lock: Press this key to toggle the Scroll Lock on and off. This function is defined by individual programs, and is usually used under DOS.

Numeric Keys

Find the numeric keys among the keyboard, and activate the Num Lock function to use these numeric keys to enter numbers and calculations.

Cursor Keys

The four cursor (arrow) keys and [Home], [PgUp], [PgDn], [End] keys are used to control the cursor movement.

The [Backspace] key, [Ins] and [Del] keys at upper right corner are use for editing purpose.





Function Keys

■ Windows Keys

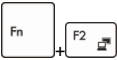
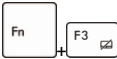
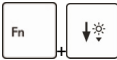
You can find the Windows Logo key () on the keyboard, which are used to perform Windows-specific functions. For more information, please refer to your Windows manual or online help.

■ General [Fn] Keys





| | |
|---|--|
|  | Switch the display output mode between the LCD, external monitor and both. |
|  | Enable or disable the touchpad function. |
|  | Decrease the LCD brightness. |

| | |
|---|--|
|  | Increase the LCD brightness. |
|  | Decrease the built-in speaker's volume. |
|  | Increase the built-in speaker's volume. |
|  | Disable the computer's audio function. |
|  | Force the computer into sleep state (depending on the system configuration). |

■ Quick Launch [Fn] Keys

Use the [Fn] buttons on the keyboard to activate the specific applications or tools.

With the help of these quick launch buttons, users will be able to do work more efficiently.

| | |
|---|---|
|  <p>User Defined or Windows Search (optional)</p> | <ul style="list-style-type: none"> ◆ Press and hold the Fn button, and then press the F4 button to launch the User Defined application. ◆ Or, press and hold the Fn button, and then press the F4 button to launch the Windows Search function. |
|  <p>ECO Engine (Power Saving)</p> | <ul style="list-style-type: none"> ◆ Press and hold the Fn button, and then press the F5 button repeatedly to switch among various power saving modes provided by ECO Engine, or to turn this function off recurrently. |
|  <p>Webcam</p> | <ul style="list-style-type: none"> ◆ Press and hold the Fn button, and then press the F6 button to turn the Webcam function on. Press again to turn it off. |
|  <p>WLAN (WiFi)</p> | <ul style="list-style-type: none"> ◆ Press and hold the Fn button, and then press the F8 button repeatedly to turn the Wireless LAN (WiFi) function on or off recurrently. |

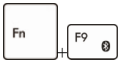

**Bluetooth
(Optional)**

- ◆ Press and hold the Fn button, and then press the **F9** button to turn the **Bluetooth** function on. Press again to turn it off.
 - ◆ This function button will not be available when the Bluetooth function is not supported.
-

Knowing the Touchpad

The touchpad integrated in your notebook is a pointing device that is compatible with standard mouse, allowing you to control the notebook by pointing the location of the cursor on the screen and making selection with its two buttons.

1. Cursor Movement Area

This pressure-sensitive area of the touchpad, allows you to place your finger on and control the cursor on the screen by moving one of your finger.

2. Right / Left Buttons

Acts as the mouse's right/ left button.

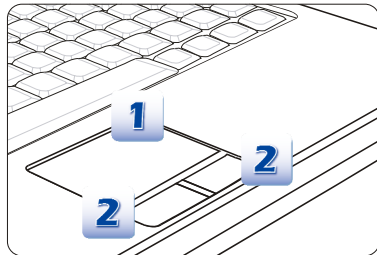

Using the Touchpad

Read the following description to learn how to use the touchpad:

■ Configuring the Touchpad

You can customize the pointing device to meet your personal needs. For example, if you are a left-handed user, you may want to swap the functions of the two buttons. In addition, you can change the size, shape, moving speed and other advanced features of the cursor on the screen.

To configure the touchpad, you can use the standard Microsoft or IBM PS/2 driver in your Windows operating system. The **Mouse Properties** in **Control Panel** allows you to change the configuration.

■ Positioning and Moving

Place your finger on the touchpad (usually using the forefinger), and the rectangular pad will act as a miniature duplicate of your display. When you move your fingertip across the pad, the cursor on the screen will move simultaneously to the same direction. When your finger reaches the edge of the pad, lift your finger and place it on a proper location of the touchpad to continue the movement.

■ Point and Click

When you have moved and placed the cursor over an icon, a menu item or a command that you want to execute, simply tap slightly on the touchpad or press the left button to select.

This procedure, called as point and click is the basics of operating your notebook. Unlike the traditional pointing device such as the mouse, the whole touchpad can act as a left button, so that your each tap on the touchpad is equivalent to pressing the left button. Tapping twice more rapidly on the touchpad is to execute a double-click.

■ Drag and Drop

You can move files or objects in your notebook by using drag-and-drop. To do so, place the cursor on the desired item and slightly tap twice on the touchpad, and then keep your fingertip in contact with the touchpad on the second tap. Now, you can drag the selected item to the desired location by moving your finger on the touchpad, and then lift your finger from the touchpad to drop the item into place. Alternately, you can press and hold the left button when you select an item, and then move your finger to the desired location; finally, release the left button to finish the drag-and-drop operation.

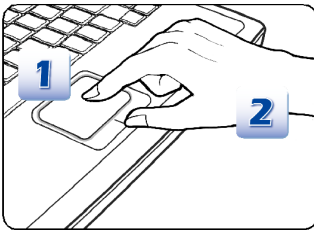

1. Move the cursor by sliding your fingertip.
2. Put your wrist on the desk comfortably.

About Hard Disk Drive

Your notebook is equipped with a 2.5-inch hard disk drive. The hard disk drive is a storage device with much higher speed and larger capacity than other storage devices, such as the floppy disk drive and optical storage device. Therefore, it is usually used to install the operating system and software applications.

To avoid unexpected data loss in your system, please backup your critical files regularly.

Do not turn off the notebook when the hard disk In-use LED is on.

Do not remove or install the hard disk drive when the notebook is turned on. The replacement of hard disk drive should be done by an authorized retailer or service representative.

Using the Optical Storage Device

Your notebook is equipped with an optical storage device. The actual device preinstalled in your notebook depends on the model you purchased.

- DVD Super Multi: Works as a multi-functional DVD Dual Drive and a DVD RAM Drive. It is capable to write CD-R, CD-RW, DVD-R/DVD-RW, or DVD+R/DVD+RW formats, and so on.
- Blu-ray: It is a high-capacity optical disc that holds the high-definition video (HD) on a single-sided disk. Blu-ray supports the more advanced H.264 and VC-1 video encoding algorithms (codecs) as well as MPEG-2, which is used for DVD. It also supports the highest HDTV resolution.

Inserting the Disk

1. Confirm that the notebook is turned on.
2. Touch the EJECT quick launch button nearby the keyboard and the disk tray will slide out partially. Note that the ODD EJECT button is functional under pure DOS system. However, in an Operating System without the S-Bar application installed, the EJECT button will not be functional. In such a case, users can right-click the ODD in "My Computer" and select "Eject" to eject the ODD tray.
3. Gently pull the tray out until fully extended.
4. Place your disk in the tray with its label facing up. Slightly press the center of the disk to secure it into place.
5. Push the tray back into the drive.

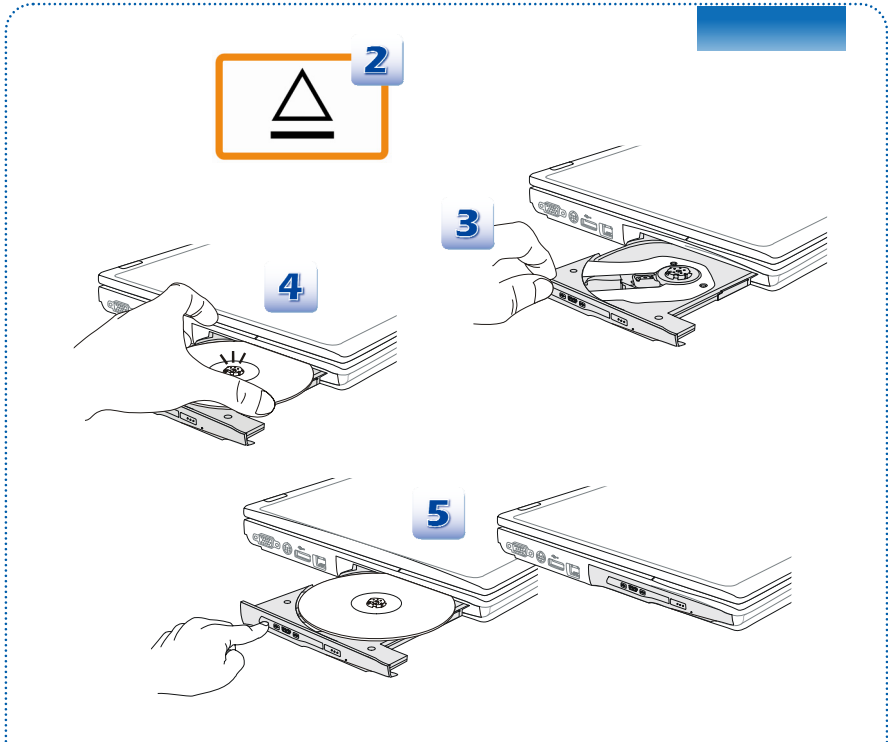

1. Confirm that the disk is placed correctly and securely in the tray before closing the tray.
2. Do not leave the disk tray open.
3. Device shown here is for reference only.

❖ Connecting the External Devices

The I/O (input/output) ports on the notebook allow you to connect peripheral devices and communication devices. All functions and devices listed here are for reference only.

Peripheral Devices



The functions listed here are supported optionally, depending on the model users purchased. Contact the local dealer for detailed information.

Communication Devices

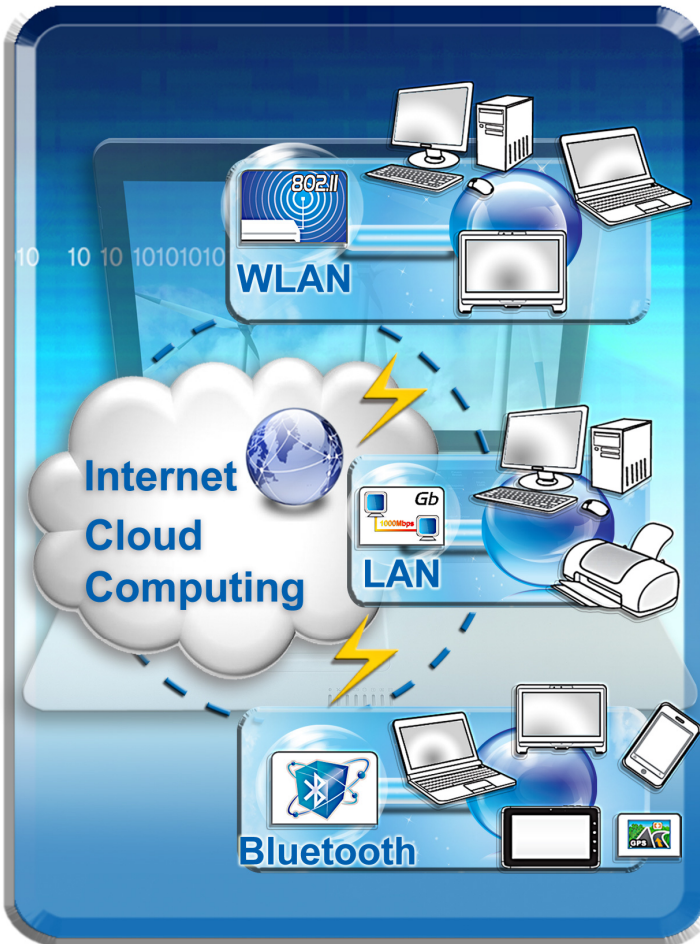

The functions listed here are supported optionally, depending on the model users purchased. Contact the local dealer for detailed information.

❖ Components Replacement and Upgrade

Please be noticed that the memory, hard disk drive, wireless LAN / Bluetooth module and battery pack preinstalled in the product users purchased may be upgradable or replaceable by user's request depending on the models users purchased.

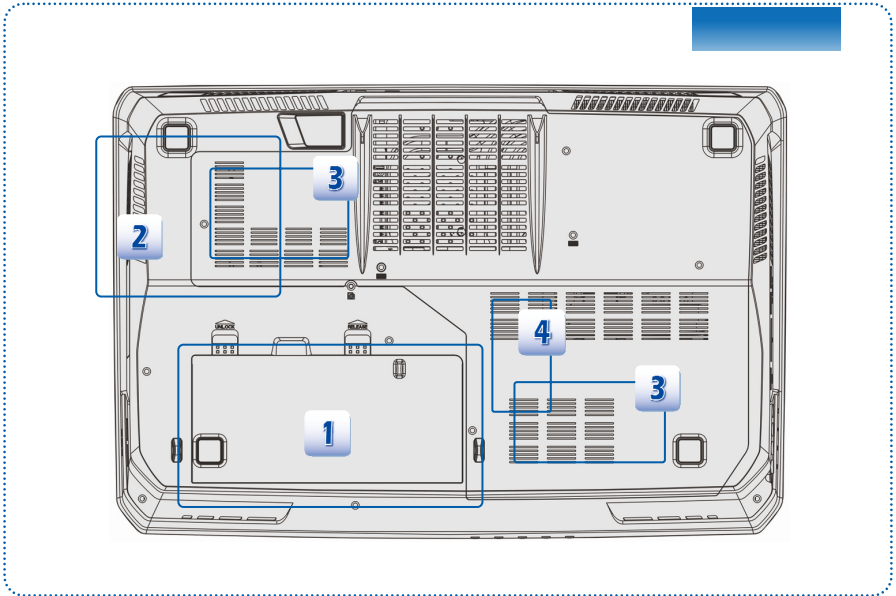

This notebook is equipped with a high-capacity Li-ion battery pack, and the battery pack is replaceable by users.



This notebook is equipped with an optical drive device, and this device may be upgradable and replaceable by the authorized dealer or service center.



This notebook is equipped with a hard disk drive, and this storage device may be upgradable and replaceable by the authorized dealer or service center.



Additional memory module may be installed, by the authorized dealer or service center, to increase the performance of this notebook, depending on the specification limitation.

To learn more about upgrade limitation, please refer to the specification in the User's Manual provided. For any further information about the product users purchased, please contact the local dealer.

Do not attempt to upgrade or replace any component of the product, if you are not an authorized dealer or service center, since it may cause the warranty void. It is strongly recommended to contact the authorized dealer or service center for any upgrade or replace service.

S-Bar is not working

Please update S-Bar to the latest version to solve the problem

Unable to boot from the built-in HDD when a bootable e-SATA hard disk is connected.

Please update BIOS to the latest version.

Error message “ERROR : BIOS has no flash information available” occurs while flashing BIOS.

This is a protection purpose to prevent the system crash if the system is out of power unexpectedly while the flash process is still on going. Please make sure the AC adaptor is connected, and then flash the BIOS.

The battery cannot be charged.**The battery LED keeps blinking and unable to charge.**

1) Update BIOS to the latest version. 2) Turn off the notebook, and disconnect the AC/DC adapter and the battery. 3) Re-connect the AC/DC adapter and the battery. 4) Leave the notebook powered off at least for 30 minutes while charging the battery. 5) If the problem remains, please contact with your local dealers or local MSI service center for further support.

The system can not wake from Sleep State.

Please update BIOS to the latest version first. to modify the register setting.

My notebook does not shut down.

It is always recommended to shut down your notebook using the Shut Down command. Using other methods, including those listed here, may result in loss of unsaved data. If the Shut Down command does not work properly, follow these steps: 1) Restart the notebook by pressing Ctrl+Alt+Delete. 2) Long press the power button to turn off the system. 3) Unplug the system from the power adapter.

My speakers have no sound.

1) Check the master volume setting in the audio Mixer. 2) If you are using an application that has its own volume control, check that the volume is turned up. 3) If you have connected an audio cable to the Headphone connector, disconnect the cable.

My Internet connection has problems.

1) Have your phone company check that your phone line is free from any line noise. 2) If you are having a problem connecting with your Internet Service Provider (ISP), check that the ISP is not experiencing technical problems. 3) Check the ADSL settings and connection and make sure your notebook is properly configured for Internet access. 4) The wireless LAN data transfer speed is affected by distance and obstructions between devices and access points. To maximize the data transfer speed, please choose any access point you may be using closer to your notebook.

Cannot play a DVD-ROM.

1) If a region code warning appears when you are using the DVD player, it could be that the DVD-ROM you are trying to play is incompatible with the DVD-ROM drive in your system. The region code is listed on the disc's packaging. 2) If you see video but cannot hear audio, check all of the following: Make sure your DVD player's mute setting is off. Check the master volume setting in the audio Mixer. 3) Check that the drivers are installed properly, click Start > Control Panel > System > Device Manager. 4) A dirty or damaged disc may cause the computer to "hang" while it tries to read the disc. If necessary, reboot the computer, remove the disc, and then check that it is not dirty or damaged. 5) Please use DVD player software like PowerDVD or WinDVD to play DVD video.

Cannot open the DVD-ROM drive tray.

1) Make sure the computer is turned on. 2) Press the Eject button on the DVD-ROM/CD-ROM drive. 3) The ODD Eject button is under controlled by SCM/ S-Bar (based on model specification). Please make sure the SCM or S-Bar utility is installed on your system. 4) If the Eject button does not work, open the tray by inserting a sharp, pointed object into the hole next to the Eject button.

